

Configure your custom made fixture

1. Choose your slot trimless profile

Type	Description	Item code
Length: 82mm (visual 52mm)	SL Trimless empty profile Length: 82mm (visual 52mm) Colour: White	WLSLT 0001
	SL Trimless empty profile Length: 82mm (visual 52mm) Colour: Black	WLSLT 0002
Length: 250mm (visual 150mm)	SL Trimless empty profile Length: 250mm (visual 150mm) Colour: White	WLSLT 0101
	SL Trimless empty profile Length: 250mm (visual 150mm) Colour: Black	WLSLT 0102
Length: 500mm (visual 400mm)	SL Trimless empty profile Length: 500mm (visual 400mm) Colour: White	WLSLT 0201
	SL Trimless empty profile Length: 500mm (visual 400mm) Colour: Black	WLSLT 0202
Length: 1600mm (visual 1500mm)	SL Trimless empty profile Length: 1600mm (visual 1500mm) Colour: White	WLSLT 0301
	SL Trimless empty profile Length: 1600mm (visual 1500mm) Colour: Black	WLSLT 0302
Length: 2100mm (visual 2000mm)	SL Trimless empty profile Length: 2100mm (visual 2000mm) Colour: White	WLSLT 0401
	SL Trimless empty profile Length: 2100mm (visual 2000mm) Colour: Black	WLSLT 0402
Length: 3100mm (visual 3000mm)	SL Trimless empty profile Length: 3100mm (visual 3000mm) Colour: White	WLSLT 0501
	SL Trimless empty profile Length: 3100mm (visual 3000mm) Colour: Black	WLSLT 0502
CUSTOM	SL Trimless empty profile Length: Custom per cm - max 590cm Colour: Custom	WLSLT XXXX









2. Choose your LED (not obligated)

Type	Variant	Power	CCT	Beam angle
WLSLLED	01 -	01 4W (9cm)	01 2700K	01 24°
		02 8W (19cm)	02 3000K	02 36°
			03 4000K	03 80°

3. Choose magnetic track for dotsi (not obligated)

Type (per cm)	Colour
WLSLRAIL (only for dotsi)	01 Black
	02 Chrome
	03 Matt chrome

4. Choose your dotsi if you have provided magnetic rail (not obligated)







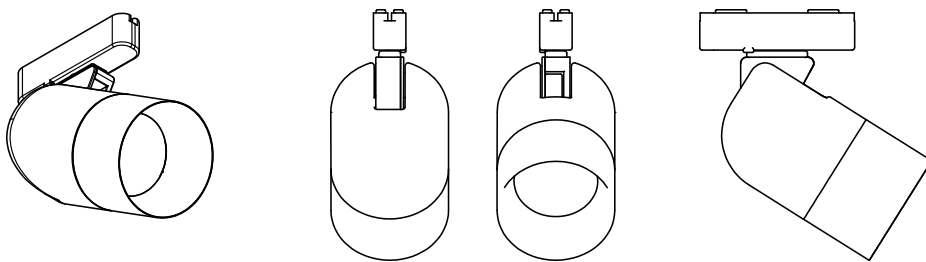





Type	Variant	Housing	Frontring	Frontring colour	CCT
WLDOTSI	01 ø 38mm	01  White RAL9016	01 Antiglare tube short	01  White RAL9016	01 2700K
		02  Ano black	02 Spot tube short	02  Ano black	02 3000K
		03  Ano champagne	03 Antiglare tube long	03  Ano champagne	03 4000K
		04  Ano bronze	04 Spot tube long	04  Ano bronze	

Required option

WL DOTSI 01LENS01	Lens for Dotsi ø38mm - 15°
WL DOTSI 01LENS02	Lens for Dotsi ø38mm - 20°
WL DOTSI 01LENS03	Lens for Dotsi ø38mm - 30°
WL DOTSI 01LENS04	Lens for Dotsi ø38mm - 40°
WL DOTSI 01LENS05	Lens for Dotsi ø38mm - 45x20°
WL DOTSI 01LENS06	Lens for Dotsi ø38mm - Wallwasher



5. Choose your tubsi pendant (not obligated)

WL + MODEL	Tube	Colour rod	Length rod	CCT
WLTUBSI	01  White RAL9016	01  White RAL9016	01 0 - 100cm	01 2700K
	02  Ano black	02  Ano black	02 101 - 150cm	02 DTW
	03  Ano champagne	03  Ano champagne	03 151 - 200cm	
	04  Ano bronze	04  Ano bronze	04 201 - 250cm	
	05  Travertin			
	06  White marble			
	07  Black marble			
	08  Black oak			
	09  Walnut			

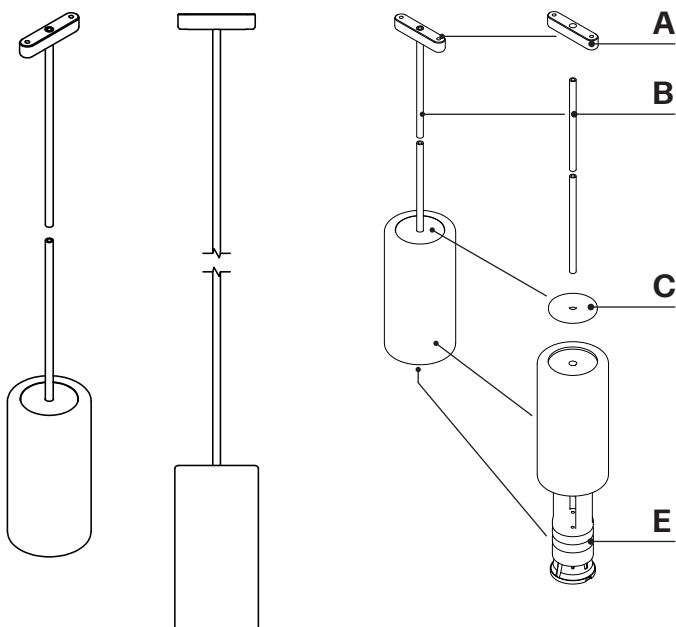

- A: Tubsi coupler
- B: Tubsi rod
- C: Tubsi rondel
- D: Tubsi tube
- E: Tubsi LED module

6. Choose your driver

Count the total wattage of the lights for each profile before choosing a driver

If you want split up the lights in different circuits, then you need to take 1 driver per circuit

Type	Description	Minimum profile length	Item code
Non dimmable	12W	10cm	WL DRIVER17
Mains dimmable	36W	30cm	WL DRIVER13
	60W	40cm	WL DRIVER16
1-10V / DALI / PUSH	70W	40cm	WL DRIVER14
Casambi	-	45cm	WL CBU-TED (+ Mains dim. driver)

Example of configured fixture

Slot trimless | black 60cm | 2x8W 2700K 36° | black dot rail 30cm | mains dim.

CODES:

WLSLT XXXX BLACK (60x)	Profile color black, length 60cm
WLSLLED 01 02 01 02 (2x)	2x Slot LED 8W, 36°, 2700K
WLSLRAIL 01 (30x)	Magnetic rail for DOTSI black, length 30cm
WL DRIVER13	Driver mains dimmable 36W

Example of slot trimless configuration possibilities

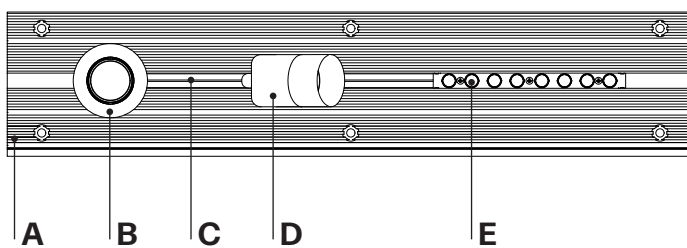
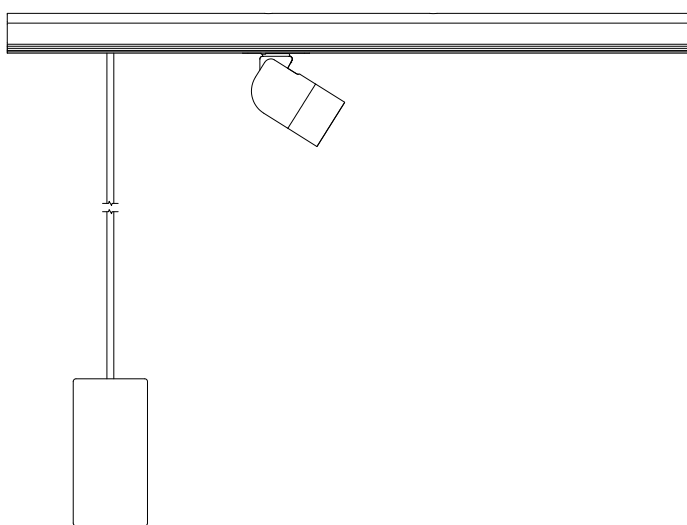
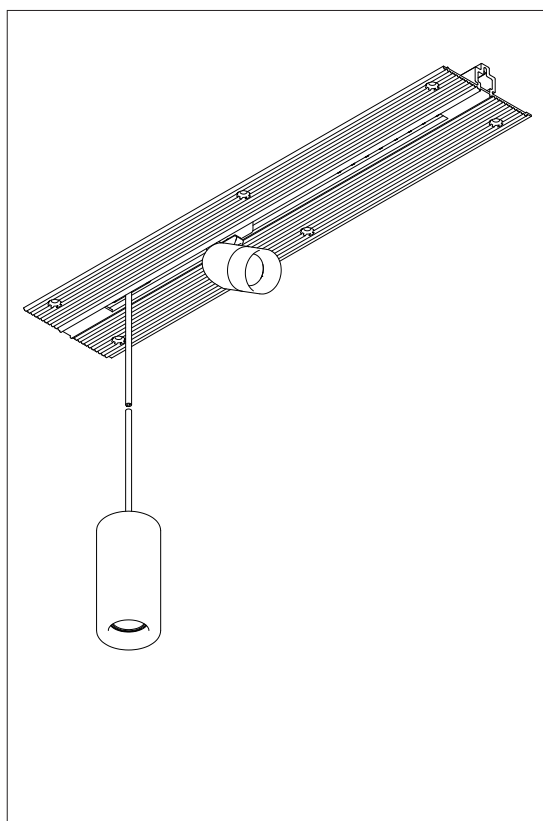

- A: White line **slot trimless profile**
- B: White line **tubsi**
- C: Magnetic **dotsi-rail**
- D: Magnetic spot **dotsi**
- E: White line **slot LED**